

- ^{ぶんどき}分度器の中心を点アに合わせて次の角度をかきましょう。

1 255°

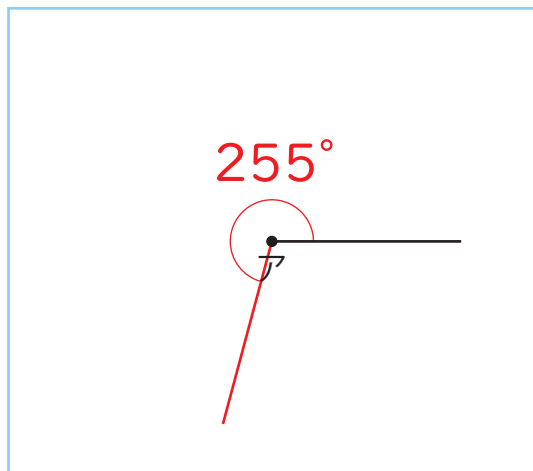

2 315°

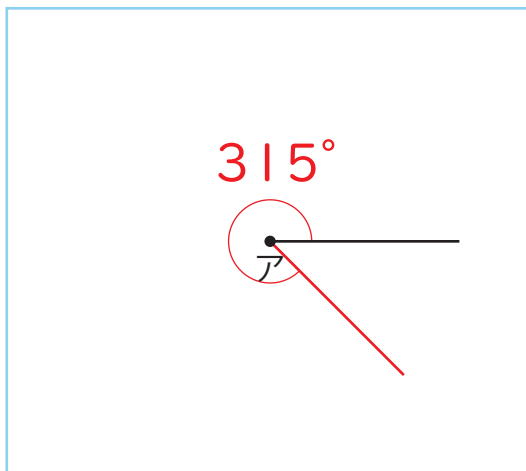

3 165°

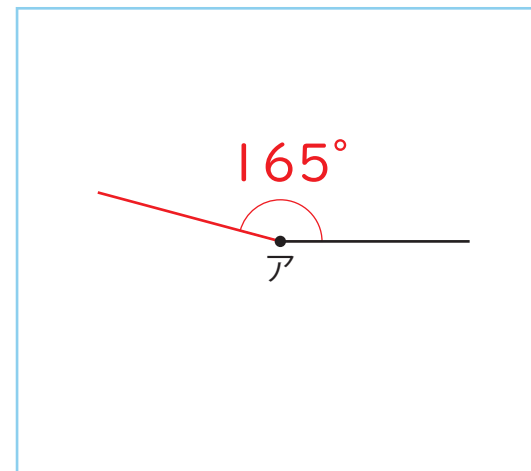

4 35°

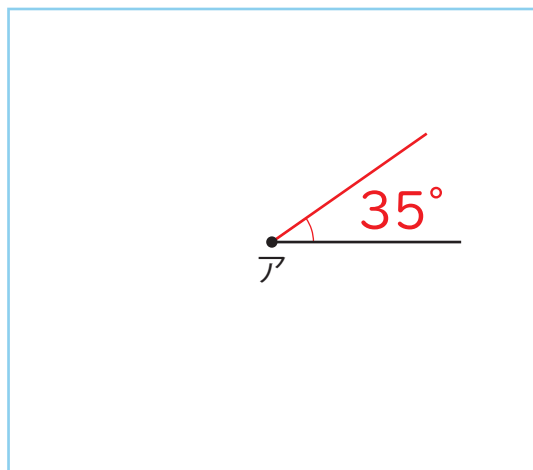

5 285°

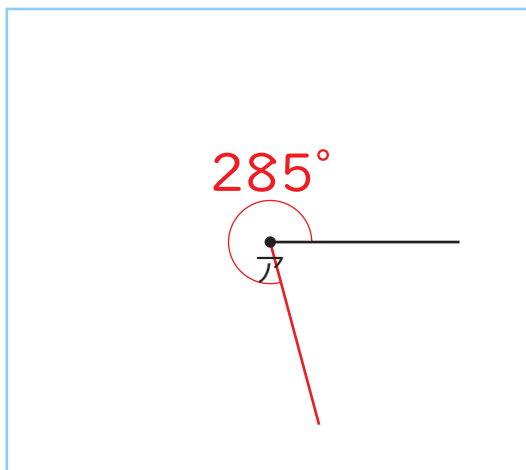

6 125°

